

uniden[®]
Beancat[®]

UBC9000XLT Auto Scanner

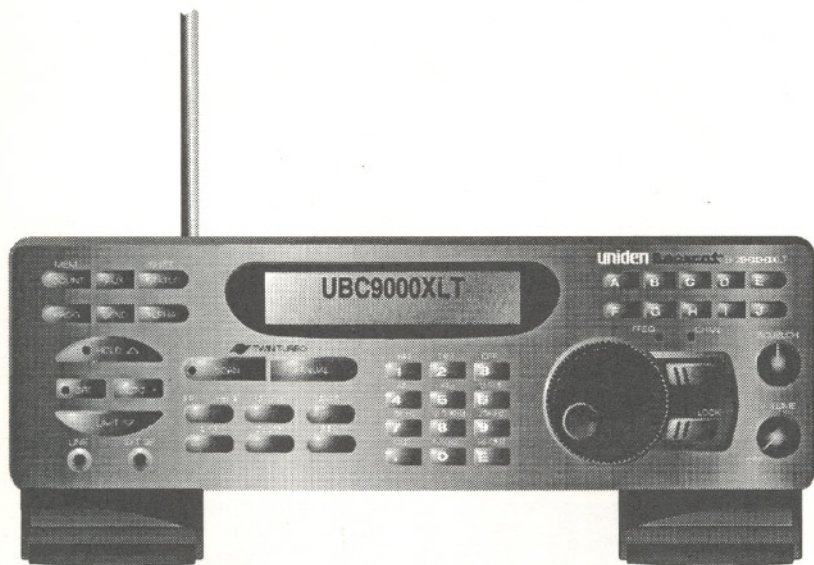

UBZZ01248AZ

OPERATING GUIDE

UBC9000XLT Controls

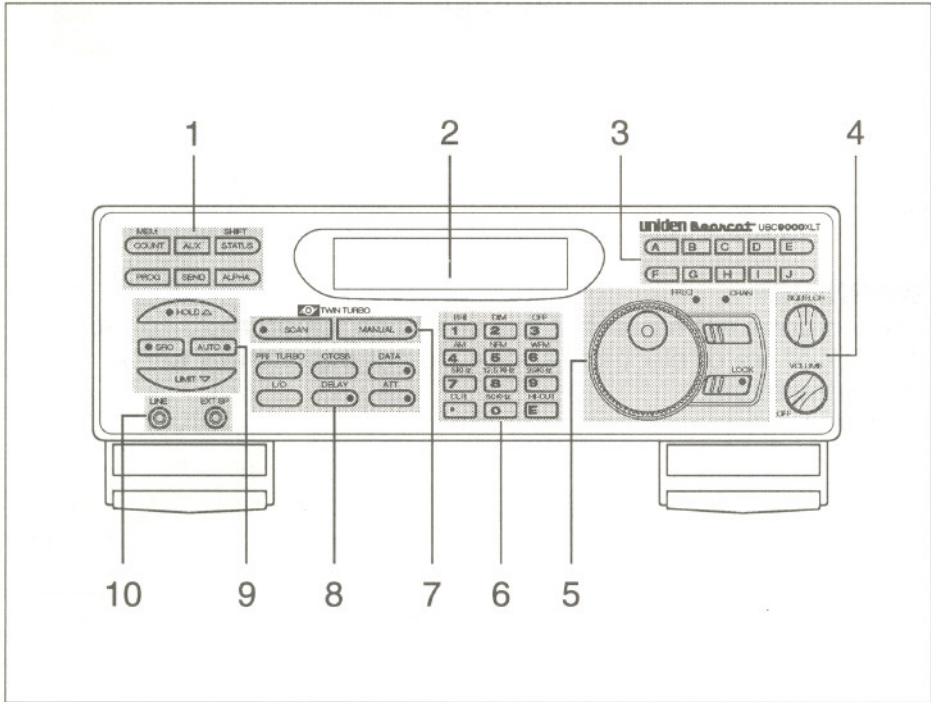

- | | | | |
|----|------------------------------------|-----|-----------------------------------|
| 1. | Programming and Status Keys | 6. | Numeric and Special Function Keys |
| 2. | Display | 7. | Scan Keys |
| 3. | Bank Keys | 8. | Mode Keys |
| 4. | ON/OFF/VOLUME and SQUELCH Controls | 9. | Search Keys |
| 5. | Rotary Tuning Controls | 10. | Output Jacks. |

Precautions

Before you use this scanner, please read and observe the following:

WARNING!

Uniden does not represent this unit to be waterproof. To reduce the risk of fire or electrical shock, do not expose this unit to rain or moisture.

Table of Contents

Introduction	2	Birdies.	33
Included with the		Additional Scanner Features	34
UBC9000XLT	3	Using Data Skip	34
Feature Highlights	4	Changing the	
Getting Started	6	Frequency Step	35
Base Installation	6	Setting the Signal Mode	36
What is Scanning?	7	Using Signal Attenuation.	37
Searching	7	Preventing	
Banks and Channels.	8	Accidental Programming.	38
Setting the Squelch.	8	Using COUNT to	
Using the Rotary Tuner.	10	Monitor Channel Activity	38
Programming Channels	11	Displaying Bank	
Programming By		Memory Status	40
Manual Entry.	12	Using Auto Recording.	41
Programming with the		Viewing Scanner	
Rotary Tuner.	13	Status Information.	42
Programming with Search	14	Display Light	44
Programming with		Using Hi-Cut	44
AUTO STORE	17	CTCSS Operation	45
Deleting a		Installing the CTCSS Board	45
Programmed Frequency.	19	Using CTCSS	47
Transferring a		To Change the	
Programmed Frequency.	19	CTCSS Tone Frequency	48
Programming Channels with		CTCSS Tone Frequencies	49
Alpha Characters	20	Care and Maintenance	50
To Delete Alpha Characters	22	Troubleshooting	51
The Scan Mode	24	Optional Accessories and	
Scanning All Programmed		Replacement Parts	52
Channels and Banks.	24	Specifications	53
Turning Banks ON or OFF	25		
Locking Out Channels	26		
Using Priority Scan	28		
The Search Mode	29		
Beginning a Search	29		
Scrolling Frequencies			
During a Search	30		
Using Turbo Search	31		
Using Search Delay	31		
Locking Out Frequencies	32		
Unlocking a Frequency.	32		
Unlocking All Frequencies	33		

Introduction

The UBC9000XLT is a sophisticated information radio with automatic scanning capabilities. You can use it at home as a base unit, or install in your vehicle as a mobile unit.

The UBC9000XLT can store frequencies such as, police, fire/emergency, marine, air, weather, and other broadcasts into 20 banks of 25 channels each. The new Rotary Tuner feature enables rapid and easy selection of channels and frequencies. And with AUTO STORE, you can automatically program any channel.

With the UBC9000XLT, you can scan all 500 channels with Turbo Scan. In the Search Mode, you can choose super fast Turbo Search. In addition, the UBC9000XLT has AUTO SORT - an automatic frequency sorting feature for faster scanning within each bank.

Types of Communication

You will be able to monitor communication such as:

- Police and fire department (including paramedics)
- Business/industrial radio
- Motion picture and press relay
- Utility
- Land transportation frequencies, such as trucking firms, buses, taxis, tow trucks, and railroads
- Marine and amateur (ham radio) bands
- Air band
- Analogue cellular telephone frequencies
- Public Service 800 MHz band

And many more in the 25-1300 MHz range.

Included with the UBC9000XLT

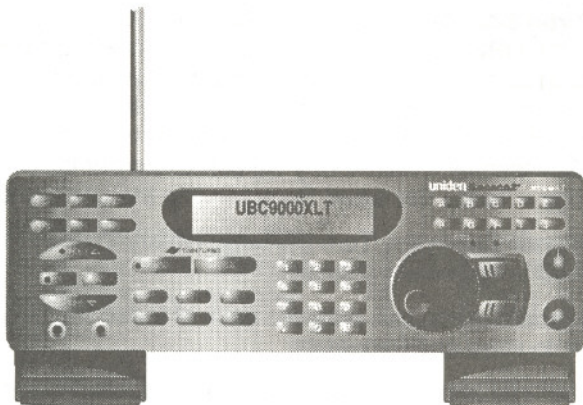

Operating Guide
(OMUBC9000XLT)

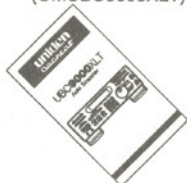

Australian
Warranty
Program



Telescoping Antenna
(AT124)



AC Adaptor
(AAD8500U)

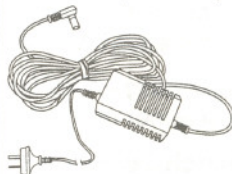

- Read this Operating Guide thoroughly before you use the scanner.
- If any of the above items are missing or damaged, contact the place of purchase immediately.

Feature Highlights

- **Twin Turbo Scan/Search** – This lightning-fast technology enables the UBC9000XLT to scan up to 100 channels per second and search up to 300 steps per second (in 5kHz steps). Because the frequency coverage is so large (see “Specifications,” page 53, for band listing), a very fast scanning system is essential. That is why we combined our latest technology – Turbo Scan and Search – into the UBC9000XLT.
- **Rotary Tuner Control** – Turn the large Rotary Tuner to select the desired frequency or channel.
- **500 Channels** – You can program each of these memory channels to store one frequency.
- **20 Banks** – Each bank contains 25 channels, useful for storing similar frequencies in order to maintain faster scanning cycles.
- **25 - 1300 MHz** – Indicates the range of frequencies that can be searched within the bands of your scanner. (**Note:** *The frequency coverage is not totally continuous between 550-760 MHz.*)
- **10 Priority Channels** – You can assign one Priority channel for each of the 10 banks, A-J. This allows you to keep track of activity on your most important channel(s) while monitoring other channels for transmissions.
- **Auto Store** – Automatically stores all active frequencies within the specified bank(s).
- **Auto Sorting** – Programmed frequencies are automatically sorted within each bank for faster scanning.
- **Auto Recording** – This feature lets you record channel activity from the scanner onto a tape recorder.
- **Scan/Search Delay**—In the Scan or Search Mode, causes the scanner to remain on a frequency two seconds after the last transmission to wait for a possible reply.
- **Direct Channel Access**—Allows you to manually select a specific channel without scanning.
- **Direct Frequency Programming**—Allows you to program a specific frequency into a channel without searching.
- **Frequency Transfer**—Lets you transfer a frequency into an empty channel, or replace the frequency in the current channel.
- **Programmable Alpha Characters**—You can program up to 250 channels with 16 alpha characters for easy reference.

- **Variable Frequency Steps (Increments)**—In the search or Manual Mode, lets you change the steps between frequencies.
- **Channel/Frequency Lockout**—Lets you temporarily remove channels or frequencies from the scanning or search cycle.
- **Signal Attenuation**—Reduces the scanner's sensitivity for unusually strong signals often found on the WFM (wide frequency modulation) bands.
- **Data Skip**—Lets you set the scanner to automatically continue searching or scanning when it encounters an unmodulated or data signal.
- **Enter Lock**—Temporarily disables programming keys to prevent accidental programming.
- **External Speaker Jack**—Allow you to connect an external speaker or earphone for custom listening. See "Included with your Scanner" on page 3, and "Optional Accessories & Replacement Parts" on page 52.
- **Line, and AUX Jacks**—Allow you to connect a tape recorder.
- **Display Light**—Lets you view the display more easily in dark or low-light conditions.

Getting Started

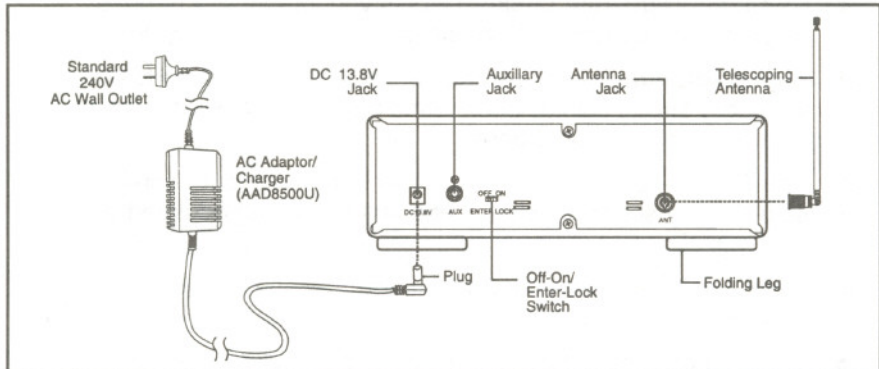

Base Installation

1. Insert the DC plug end of the AC Adaptor into the DC 13.8V jack on the rear panel.
2. Plug the AC Adaptor into a standard 240V AC wall outlet.
3. Plug the Telescoping Antenna into the "ANT" connector. Extend the antenna to its full height. For frequencies higher than 406 MHz, shortening the antenna may improve the reception.
4. If you need a better viewing angle, flip the folding legs down to raise the front of the scanner.

For use with an optional external speaker:

Plug the external speaker into the "EXT SP" jack located on the front of the scanner.

For use with an optional tape recorder:

Be sure to use a tape recorder with microphone and remote input jacks.

1. Connect a cable from the "LINE" jack on the front of the scanner to the microphone input of a tape recorder.
2. Connect a cable from the RCA-type "AUX" jack on the back of the scanner to the recorder's "REMOTE" jack. (See "Using Auto Record," page 41.)

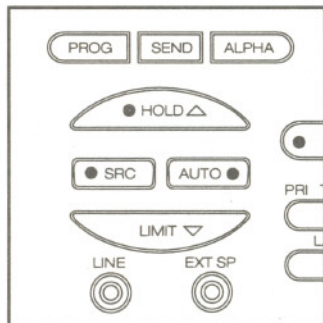

For use with an optional CTCSS Tone Board:

CTCSS Board Socket (inside the unit). See "CTCSS Operation," page 45.

What is Scanning?

Unlike standard AM or FM radio stations, most two-way communications (listed below) do not transmit continuously. The UBC9000XLT scans programmed channels at the rate of up to 100 channels per second until it finds an active frequency. Scanning stops on an active frequency, and remains on that channel as long as the transmission continues. When the transmission ends, and no response is detected, the scanning cycle resumes until another transmission is received.

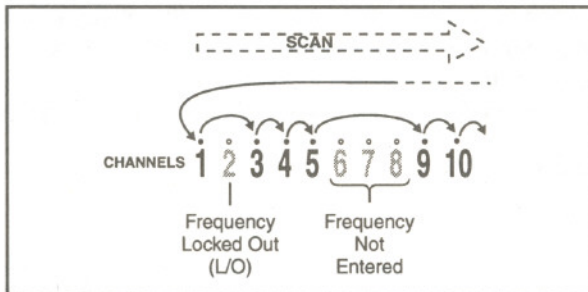

An optional DELAY can be set so that the scanner stays on the channel for 2 more seconds, waiting for another transmission before resuming scanning.

Searching

Scanning and searching are similar in that they both involve finding active frequencies within a group of frequencies. The difference is *Scanning* looks only at a group of *programmed* frequencies that are stored in the scanner's channels and grouped into banks.

Searching looks at all the frequencies within a pre-selected range of frequencies.

If you find an interesting frequency while searching, you can store it in a channel for easier access later. See "Programming with Search" on page 14. *The main purpose of the Search function is to help you find active frequencies to program into memory.*

CTCSS Operation

This section applies only if you are installing and using an optional CTCSS Tone Board with your scanner.

Installing the CTCSS Board

Installing the CTCSS Tone Board is a simple procedure, and requires only a few minutes following the steps below.

CAUTION: *Be sure to turn the scanner off and disconnect the power cord before attempting to open the scanner.*

1. Remove the five screws from the top cover.

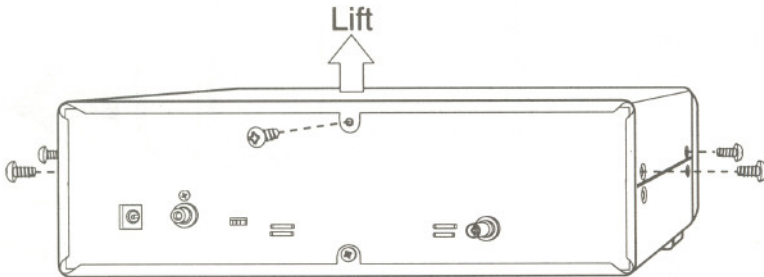

2. Carefully lift the cover up from the back of the unit and turn it to the left – being careful not break the speaker wire.
3. Stand the cover on its left side panel.

(Continued, next page)

2. Think of the Squelch Control as a gate. Turn **SQUELCH** fully counterclockwise. This raises the “Squelch Gate” so high that no signals can get through.

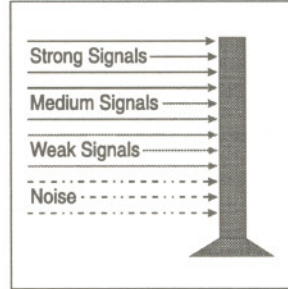
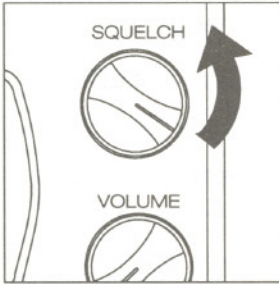

3. Turn **SQUELCH** fully clockwise until you hear a hiss. This lowers the “Squelch Gate” so that everything gets through ... noise, weak signals, and strong signals.

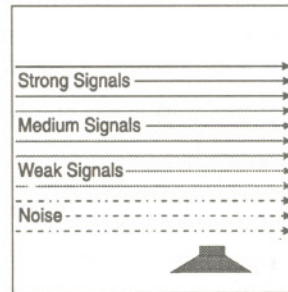
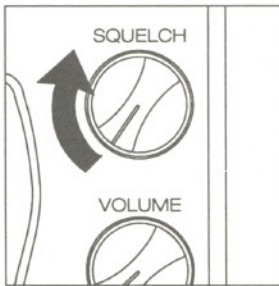

4. Turn **SQUELCH** back counter clockwise just until the hiss stops. Now the “Squelch Gate” allows only strong signals through.

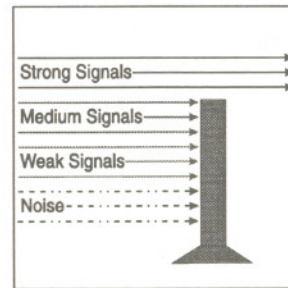
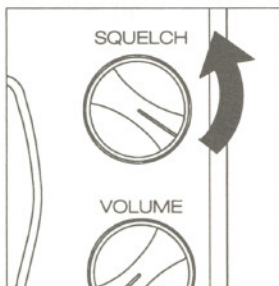

Using the Rotary Tuner

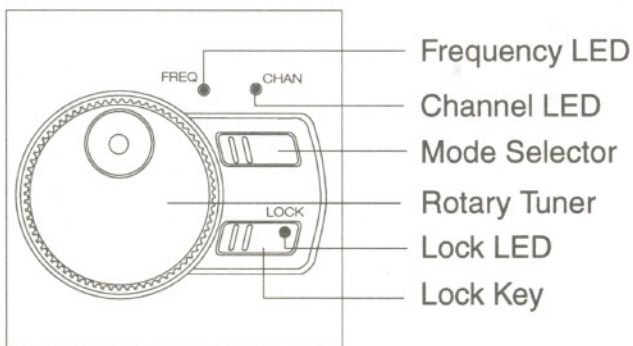

Rotary Tuner and Controls

This unique feature allows easy, rapid, and precise selection of frequencies and channels in the UBC9000XLT.

Frequency/Channel Mode Selector - Press to switch between channel or frequency mode. When the CHAN LED is on, you can step rapidly through channels with the Rotary Tuner. When the FREQ LED is on, you can tune quickly and accurately through frequencies with the Rotary Tuner.

Rotary Tuner - Use the Rotary Tuner to step through channels or frequencies, depending on the setting of the Frequency/Channel Mode Selector. Turn the knob clockwise to step up, counter clockwise to step down.

Lock Key/LED - The LED lights when the Rotary Tuner is locked. Press **LOCK** to enable the Rotary Tuner.

Programming Channels

Before you can scan, you must program the channels within a bank. You can store one frequency per channel, up to 500 channels. These are the banks and their associated channels:

Bank	Channel Number	Bank	Channel Number
A	1 - 25	1	251 - 275
B	26 - 50	2	276 - 300
C	51 - 75	3	301 - 325
D	76 - 100	4	326 - 350
E	101 - 125	5	351 - 375
F	126 - 150	6	376 - 400
G	151 - 175	7	401 - 425
H	176 - 200	8	426 - 450
I	201 - 225	9	451 - 475
J	226 - 250	0	476 - 500

Auto Sort

Each time you store a frequency, the list of scanning frequencies in the bank is automatically sorted by frequency number. This unique Auto Sort feature enables faster scanning. When you manually step through a bank, however, frequencies are sorted according to channel number.

Choosing a Programming Method

With the UBC9000XLT, there are five ways to program a channel:

- Manually selecting a channel and frequency, using the numeric keypad
- Using the Rotary Tuner to select a channel and frequency
- Searching a band to find active frequencies, and then storing them into channels
- Using the Auto Store feature to automatically program channels
- Transfer a programmed frequency from another channel

Programming By Manual Entry

Use these keys :

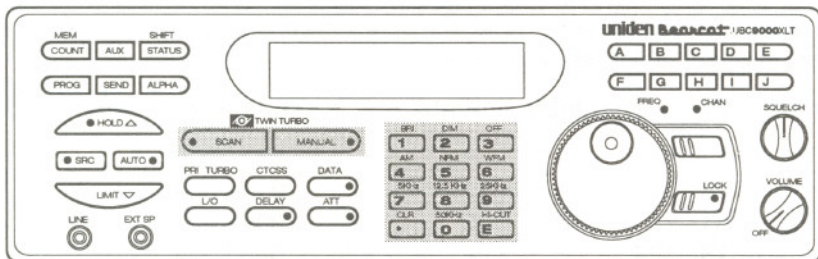

Scan and Numeric Keys

1. Select a frequency.

Example: Program

482.7625 MHz into Channel 1.

2. Press **MANUAL** to enter the Manual Mode.

Bank A ch 22
L/O 000.0000MHz

3. Enter the channel number, then press **MANUAL**.

Bank A P ch 1
L/O 000.0000MHz

4. Enter the frequency. Then press **E**.

Example: 482.7625

If you make a mistake, press

CLR twice to erase.

Bank A P ch 1
482.7625MHz

If an error is made during programming, or if the frequency is out of range, this screen appears. Enter a valid channel or frequency number.



If the frequency is stored in another channel, the display will indicate the original channel for that frequency.



To program more channels, repeat steps 3 and 4.

Press **E** to store the same frequency into the selected channel.

Or, select another channel.

Or, press **CLR** twice to clear.

Programming With the Rotary Tuner

Use these controls:

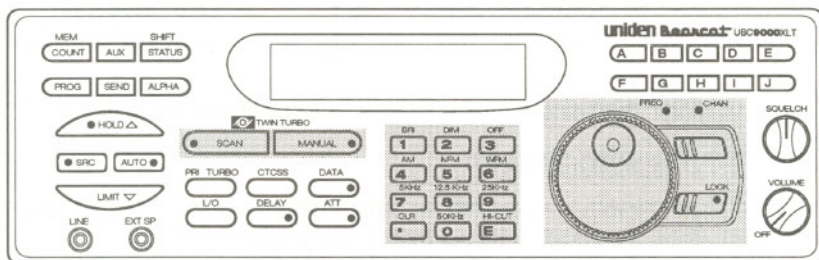

Scan, Numeric Keys, and Rotary Tuning Controls

1. Press **MANUAL** to enter the Manual Mode.
OR
Turn the Rotary Tuner.

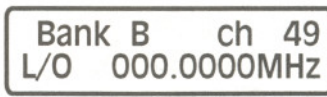

Note: Make sure the **LOCK** LED is out.

2. Select **CHAN** with the Rotary Tuner Mode Selector, then turn knob.
Example: channel 52
Turn right to step up through channels, left to step down through channels.

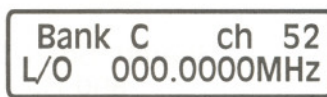

3. Select a frequency.
Example: 123.7750

4. Enter the Frequency.
Then press **E** .

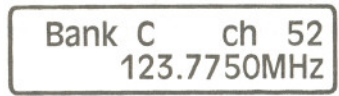

5. To turn to a new frequency, select **FREQ** with the Rotary Tuner Mode Selector then turn right to step up, left to step down.
Example: 123.7875 (turn right)



Note: The channel indicator flashes on the display, indicating that the frequency displayed is not programmed in that channel.

6. Press **E** to program the channel.

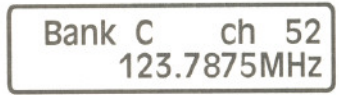

To program more channels with the Rotary Tuner, repeat steps 2 - 6.

Programming with Search

The Search feature lets you search for active frequencies in a range you choose and store any or all of those frequencies into channels.

For more information about searching, see "The Search Mode," page 29. Use these keys:

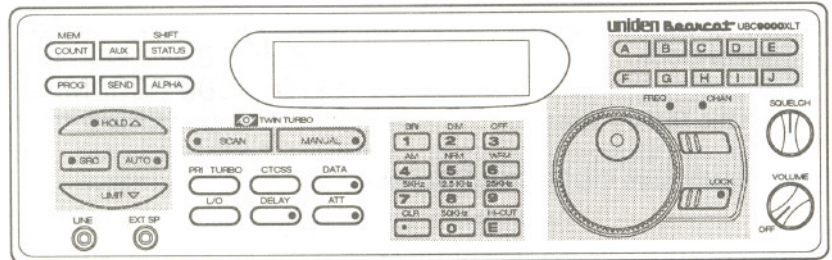

Search, Scan, Numeric, and Bank Keys,
and Rotary Tuning Controls

Note: Be sure to set SQUELCH before you begin a search. See "Setting the Squelch," page 8.

1. Select a frequency range.

See page 53.

Example: 450.000MHz to 456.000 MHz

2. Press **MANUAL**.

3. Enter the frequency and press **LIMIT** to enter the lower limit of the search range.

Example: 450.000 MHz

NFM 450.0000MHz

4. Enter the frequency and press **LIMIT** to enter the upper limit of the search range.

Example: 456.000 MHz

NFM 450.0000MHz
NFM 456.0000MHz

5. Press **SRC** to begin the search function.

To exit search, press **MANUAL**.

SRC NFM 12.5 KHz
↑ 450.3750MHz

The scanner stops on the first active frequency it finds.

SRC NFM 12.5 KHz
↑ 450.3750MHz

- To program the frequency, press **HOLD** to stop searching. Then, proceed to step 6a, 6b, or 6c.
- If you do not want to program the frequency, press **SRC** to continue searching.

- 6a. Program the frequency into the current channel.

Press **E**.

12.5KHz ch 53
NFM 450.3875MHz

Bank C ch 53
450.3875MHz

- 6b. Program the frequency into another channel:

12.5KHz ch 53
NFM 450.3875MHz

1. Press  to enter the Transfer Mode.

Enter Bank or ch
450.3875MHz

2. Enter the channel number.
Example: Channel 200.

200
450.3875MHz

3. Press .

Bank H ch200
000.0000MHz



(Display flip-flops)

450.3875MHz

4. Press  to Program the frequency.

Bank H ch200
450.3875MHz

6c. Program the frequency into the first open channel of another bank.

1. Press  to enter the Transfer Mode.

12.5KHz ch ~~53~~
NFM 450.3875MHz

2. Choose a bank.
Example: Press .

Enter Bank or ch
450.3875MHz

Note: Press  and bank (0~9) key to choose a bank 0 through 9.

Bank I P ch201
450.3875MHz

3. Press .

Bank I P ch201
450.3875MHz

Programming With AUTO STORE

This procedure searches a frequency range and automatically stores active frequencies into empty channels of the selected bank(s).

Note: Be sure to set **SQUELCH** before you begin a search. See "Setting the Squelch" on page 8.

Use these keys:

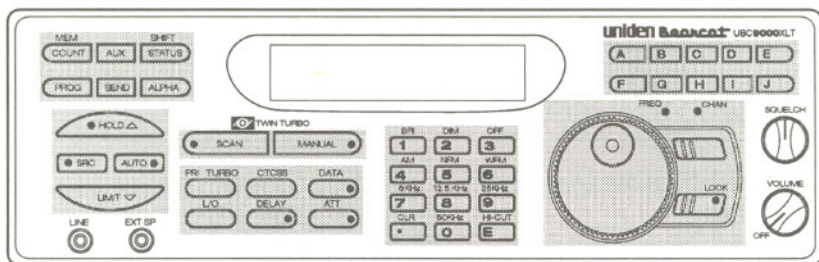

Programming, Search, Scan, Mode, Numeric, and Bank Keys and Rotary Tuning Controls

1. Select a frequency range.

See page 53.

Example: 810.000 MHz to 856.000 MHz

2. Press **MANUAL**.
3. Enter the frequency and press

LIMIT to enter the lower limit of the search range.

Example: 810.000 MHz

NFM	456.0000MHz
NFM	810.0000MHz

4. Enter the frequency and press

LIMIT to enter the upper limit of the search range.

Example: 856.000 MHz

NFM	810.0000MHz
NFM	856.0000MHz

5. Press **AUTO** to enter the Auto Store Mode.



6. Select the bank(s) for programming. The selected bank indicator(s) stop blinking.

Example: Press **C** and **D**.



7. Press **SRC** to begin the Auto Store.

The LED on the **AUTO** key flashes.

Note: You hear no audio during Auto Store.

Note: If the bank you chose is already fully programmed, a double beep sounds. Choose another bank.

Searching frequencies



Storing an active frequency.



Search resumes.



To stop Auto Store, press **MANUAL**, **SCAN**, **AUTO**, or **HOLD**.

You can change these functions during Auto Store:

Frequency Step (See page 35.)

Turbo Search (See page 31.)

Signal Mode (See page 36.)

8. The unit tells you when Auto Store is complete.



Deleting a Programmed Frequency

Use this procedure when you want to delete a frequency from a channel without storing a new frequency in its place.

Use these keys:

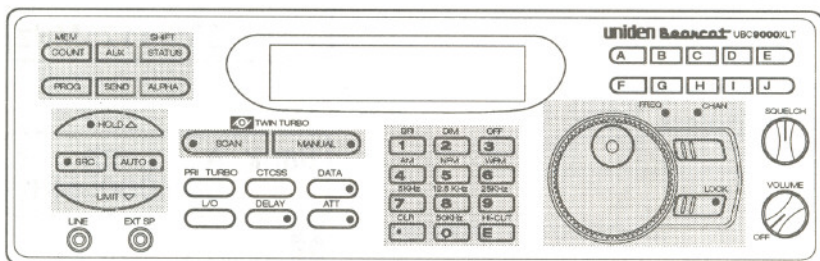

Programming, Search, Scan, Numeric Keys, and Rotary Tuning Controls

1. Enter the channel number.

Bank D ch 86
854.8625MHz

2. Press **[O]**.
3. Press **[E]**.

Bank D ch 86
L/O 000.0000MHz

Transferring a Programmed Frequency

This procedure lets you transfer a programmed frequency to another channel.

1. Press **[MANUAL]**.

Bank C ch 53
450.3875MHz

2. Enter the channel number and press **[MANUAL]**, or select **CHAN** with the Rotary Tuner Mode Selector and locate the channel.

Bank D ch 83
855.9125MHz

3a. To select the transfer channel, press **SEND** ...

Enter Bank or ch
855.9125MHz

3b. Then enter the channel number...

8
855.9125MHz

3c. Then press **HOLD**.

Bank A ch 8
000.0000MHz



(Display flip-flops)

Bank D ch 83
855.9125MHz

4. Press **E** to transfer the frequency.

Bank A ch 8
855.9125MHz

Programming Channels with Alpha Characters

Use this feature to name programmed channels (up to 250 channels) for easy reference.

Example: Channel 1, Local Police.

Use these keys:

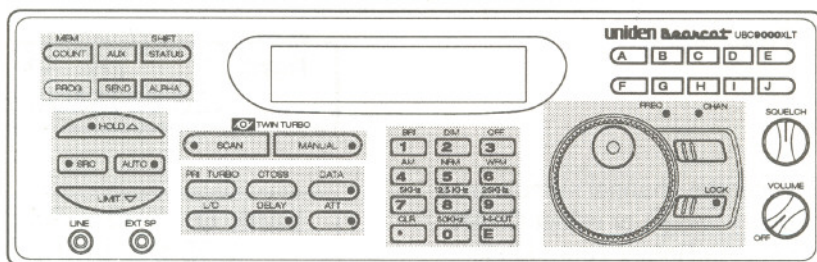

Programming, Search, Scan, Mode, and Numeric Keys,
and Rotary Tuning Controls

1. Press  ...

Select
ALPHA or CTCSS

Then press .

Select chan 
from 1 to 500

2. Enter the channel number...

Note: You must select a
programmed channel.

Example: Channel 1

1
from 1 to 500

Then press . The Alpha
Edit Screen appears.

56789  /()& ch 1

3. Turn the Rotary Tuner left/right
to choose a letter from the
upper line of characters.



Example: "L"

 MNOPQRSTU ch 1

Press  for uppercase
characters,  for lowercase
letters.

 MNOPQRSTU ch 1
L 

Repeat to choose more characters. You can enter up to 16 characters.

Note: Press  to move the edit cursor on the lower line to the right.
Press  to move the edit cursor to the left.

4. Press  to program the
Alpha entry into the channel.

Bank A P ch 1
Local Police

Select chan 
from 1 to 500

You can program up to 250 channels with alpha characters. If you try to
program channels over 250, "FULL ALPHA MEM" appears in the screen.

Press , , or  to exit the Program Alpha mode.

To display the alpha characters, press  while in the Scanning or
Manual Mode.

To Delete Alpha Characters

Use these keys:

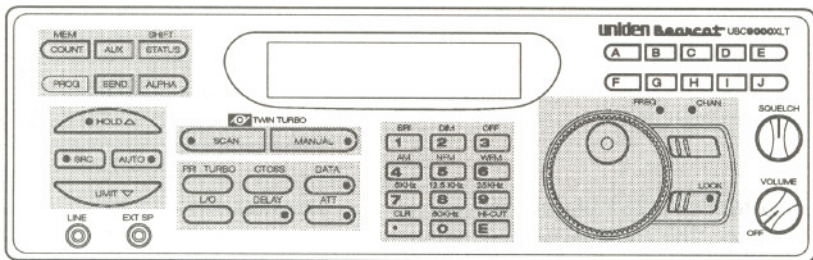

Program, Search, Scan, Mode, Numeric Keys, and Rotary Tuning Controls

1. Press **MANUAL**.
2. Press **PROG**

Select
ALPHA or CTCSS

Then press **ALPHA**.

Select chan 8
from 1 to 500

3. Enter the channel number with the alpha characters you want to delete, then press **HOLD**.

1
from 1 to 500

4. Turn the Rotary Tuner and select the space between the "9" and the "/" characters.

56789 / () & ch 1
ocal Police

5. Press **HOLD** to erase the first letter.

56789 / () & ch 1
ocal Police

6. Press **HOLD** repeatedly to erase all the letters.

7. Press **E** to store the changes.

Bank A ch 1

Select chan  1
from 1 to 500

- 8 Press **SCAN**, **MANUAL**, or **PROG** to exit the Program Alpha Mode.

The Scan Mode

Scanning All Programmed Channels and Banks

Use these keys:

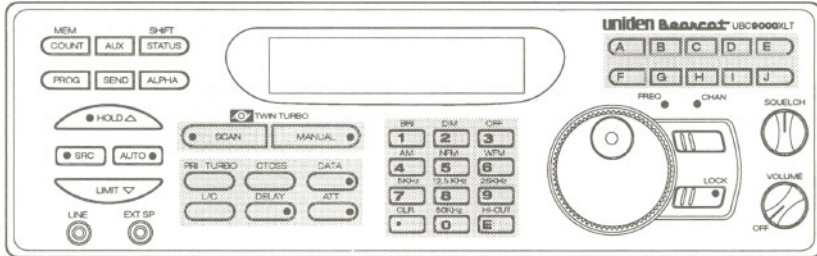

Scan, Mode, Numeric, and Bank Keys

1. Turn on the scanner
OR
Press to begin scanning.



2. When the scanner stops on a channel you can:

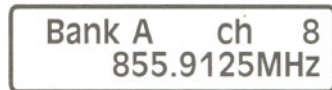

- 2a. Press to stay on the channel.
- 2b. Press to turn on Delay.
- 2c. Or press to resume scanning.



Turning Banks ON or OFF

After you have programmed channels in several of the scanner's banks you can customize which channels you scan by turning the banks on or off.

1. Press .



Bank ABCDEFGHIJ
Scan 1234567890

2. To turn a Bank OFF, press the letter or number.

Example: , , , ,
, , , ,
, , , .



Bank ABCDEF
Scan 1 5 7

3. To turn a Bank ON, press the number or letter again.

Example: , , .



Bank ABCDEF I
Scan 1 5 7 0

Locking Out Channels

The lock-out feature lets you further customize the channels that you want to scan at a particular time.

For example, if a stored frequency broadcasts almost all the time, the scanner will stop on it and stay. You can lock out that channel when you are more interested in the other channels for the current scanning session.

When you lock out a channel, it is temporarily excluded from scanning, but it remains programmed so that you can easily unlock it for scanning later.

Use these keys:

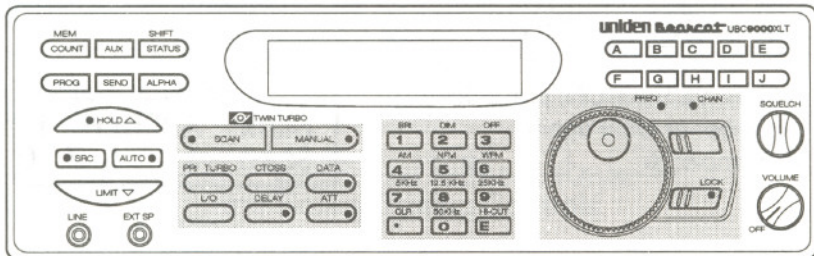

Scan, Mode, and Numeric Keys, and Rotary Tuning Controls.

Locking Out a Channel

1. Press **SCAN**.



2. Scanner stops on an undesired channel.

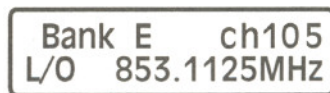

3. Press **L/O** to lock out the channel.
Scan resumes immediately.



Unlocking a Channel

1. Press **MANUAL**.
2. Enter the channel or press the Channel Mode Selector and use the Rotary Tuner to find the channel you want to unlock.

Bank A P ch 1
L/O 482.7625MHz

3. Press **L/O**.

Bank A P ch 1
482.7625MHz

4. Press **SCAN** to resume scanning.

Unlocking All Channels in selected Scan Banks.

1. Press **MANUAL**.

Bank D ch 53
450.3875MHz

2. Press and hold **L/O**.

You hear a double beep when all channels are unlocked, except 000.0000MHz.

Using Priority Scan

You can program one Priority Channel in each of the first 10 banks. During Priority Scanning, your scanner checks these special channels every two seconds, whether or not the scanner has located an active channel.

Use these keys:

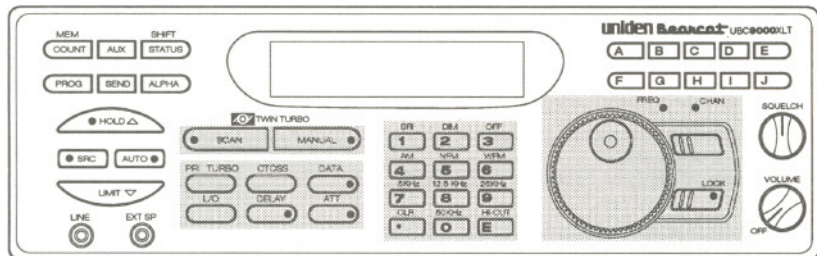

Scan, Mode, and Numeric Keys, and Rotary Tuning Controls.

Press **PRI**.

You can turn Priority Scan ON in Scan Mode or Manual Mode.



Moving the Priority Channel

The scanner is pre-programmed with the first channel of each bank as a priority channel. However, you can change the priority channel to be any other channel within the bank.

1. Press **MANUAL**.
2. Select the new priority channel.
Example: Press **9**, then **MANUAL**.
OR
Use the Rotary Tuner.
3. Press and hold **PRI** for two seconds. You hear a beep.

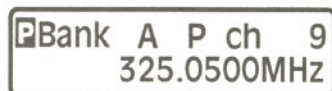
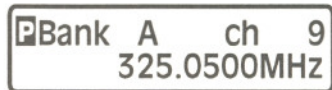

The Search Mode

In the Search Mode, the scanner looks for any active frequencies within a range of frequencies you select. It is best to select a narrow range, so that you have a better chance of finding all the active channels.

Use Search if you don't have a frequency directory handy, or if new stations have been added since the directory was published.

Use these keys:

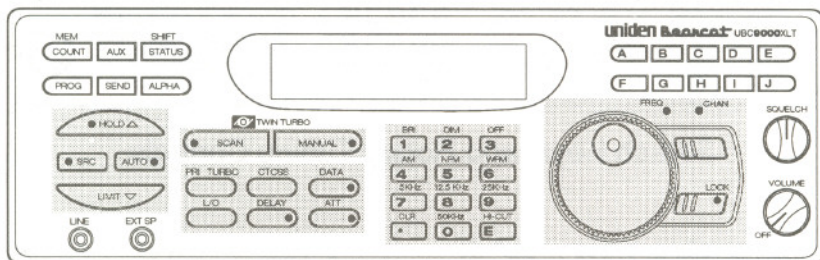

Search, Scan, Mode, Numeric and Special Function Keys, and Rotary Tuning Controls

Beginning a Search

1. Select a frequency range
(See page 53.)
Example: 46.000 MHz to 48.000 MHz

2. Press **MANUAL**.
3. To enter the lower limit of the search range, enter the frequency and press **LIMIT**.

```
NFM 46.0000MHz
NFM 856.0000MHz
```

4. To enter the upper limit of the search range, enter the frequency and press **LIMIT**.

```
NFM 46.0000MHz
NFM 48.0000MHz
```

5. Press **SRC** to begin the search.

```
SRC NFM 5.0 KHz
↑ 47.1400MHz
```



Scrolling Frequencies During a Search

Scrolling temporarily suspends a search and allows you to manually move up or down through the frequencies.

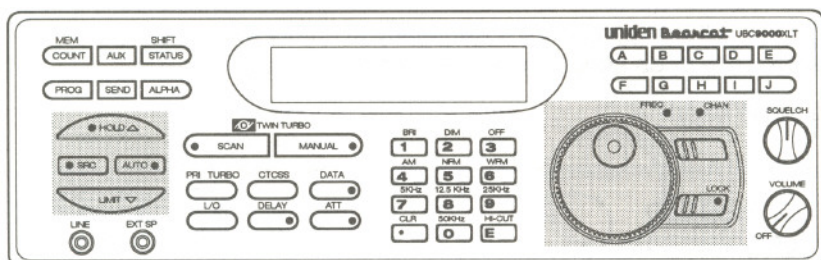
Use these keys:



Search Keys, and Rotary Tuning Controls

To begin scrolling, press  to step up ...

5.0KHz ch-230
NFM 47.7000MHz

Or press  to step down.

5.0KHz ch-230
NFM 47.6250MHz

Press and hold  or  to scroll rapidly.

OR

Select **FREQ** with the Rotary Tuner mode selector and use the Rotary Tuner. Turn the knob right to step up, left to step down.

Using Turbo Search

Turbo Search increases the search speed from 100 frequencies per second to 300 frequencies per second in ranges where the frequencies are spaced 5 kHz apart.

Use these keys:

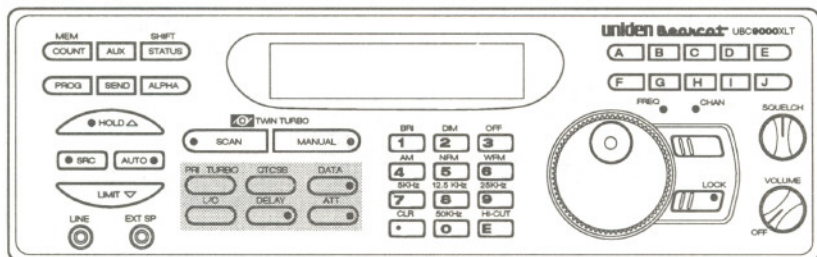

Mode Keys

While searching, press **TURBO**.



Using Search Delay

On some two-way channels there might be short lapses in the signal before a reply. The *Search Delay* feature causes the scanner to wait two seconds after the end of a transmission before resuming searching, in case there is a reply.

Unlike Scan Delay, you don't have to turn on Search Delay for each frequency in the search range. Search Delay works for the entire frequency range you chose.

Press **DELAY** to turn Search Delay ON or OFF.

Locking Out Frequencies

This feature is similar to locking out a programmed channel, except you can only lock out 50 frequencies.

Use these keys:

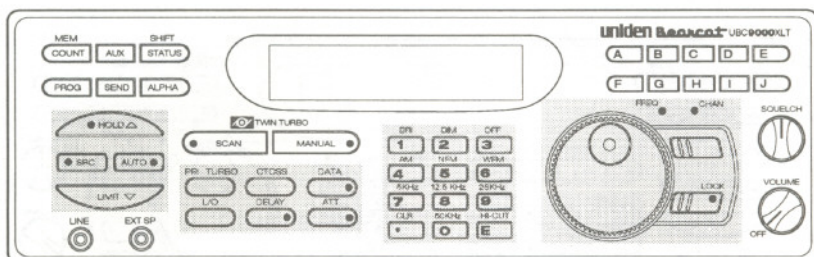

Search, Mode, Numeric Keys, and Rotary Tuning Controls

While searching press **L/O** when the scanner stops on an undesired frequency.

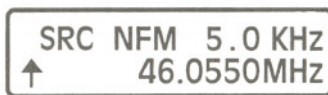

Search resumes immediately.

Unlocking a Frequency

1. Press **HOLD** to stop the search.

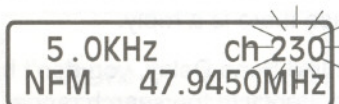

2. Press **▲** or **▼** to find the frequency you want to unlock. Or choose **FREQ** with the Rotary Tuner Mode Selector and tune in the frequency.

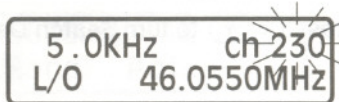

3. Press **L/O**.

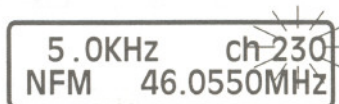

Unlocking All Frequencies

1. Press  to stop the search.
2. Find any locked-out frequency.

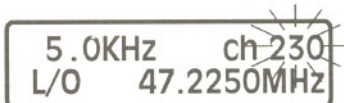

5.0KHz ch 230
L/O 47.2250MHz

3. Press and hold  for two seconds.

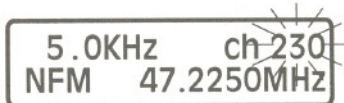

5.0KHz ch 230
NFM 47.2250MHz

You hear a double beep when all frequencies are unlocked.

Birdies

Birdies are internally generated frequencies that cause the scanner to stop during search. If you have problems with these frequencies, use the lockout features to keep the scanner from stopping.

Birdie Frequencies in MHz	
32.000	428.5875
74.200	431.9875
128.000	443.9375
139.995	447.9875
140.000	471.9875
167.995	483.9250
171.250	511.9250
312.4375	794.5500
312.4625	811.9750
383.9875	967.9125
407.9875	967.9875
415.9375	1084.0625
423.5875	1084.1375
423.9875	

Additional Scanner Features

Use these keys:

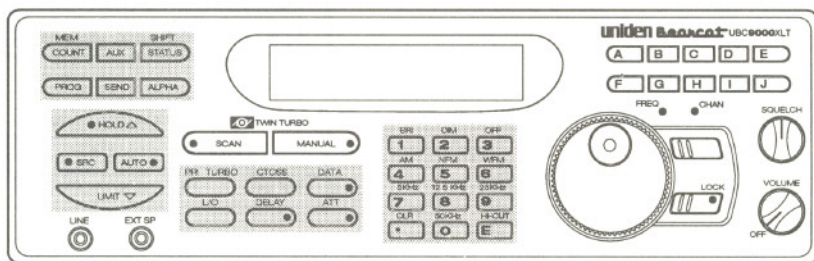

Status, Search, Mode, Numeric and Special Function Keys

Using Data Skip

Some frequencies carry un-modulated signals or data signals (such as pager preamble signals or telefax signals). You can set the scanner to continue scanning after a 3-second delay, when it encounter such signals.



Press **DATA** to turn Data Skip ON.

Note: *Data Skip* is not available for the AM band and is not active during Priority scan.

Note: You can turn *Data Skip* on or off at any time during scanning, searching and during Auto Store.

Changing the Frequency Step

The frequency step is the minimum space between frequencies in the Manual or Search Mode.

Your scanner is pre-programmed with a default frequency step for each of its frequency bands. You can override the default frequency step to search in larger or smaller increments when searching, during Auto Store, or when stepping through frequencies with , , or the Rotary Tuner.

1. Press  to stop the search.



5.0KHz ch 230
NFM 48.0000MHz

2. Press .

3. Press the desired step on the numeric keypad.

Example: Press .



50.0KHz ch 230
STEP: 50.0KHz

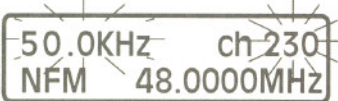

50.0KHz ch 230
NFM 48.0000MHz

To return to the original frequency step, press  twice.



5.0KHz ch 230
NFM 48.0000MHz

Setting the Signal Mode

Your scanner is capable of receiving three signal modes:

- AM Amplitude Modulation
- NFM Narrow Frequency Modulation
- WFM Wide Frequency Modulation

Each of the scanner's frequency bands is pre-programmed with a default signal mode. If you want to override the default signal mode for a particular frequency, use these keys:

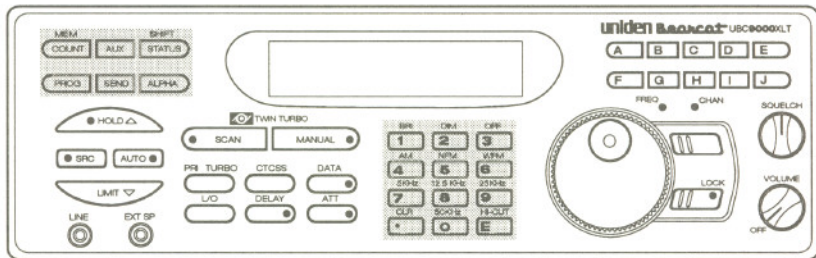

Status, Numeric and Special Function Keys

1. Press **SHIFT**.
2. Press the signal mode.

Example: **WFM**.

SRC - WFM - 5.0KHZ
MODE: WFM

SRC WFM - 5.0 KHZ
↑ 46.6000MHZ

Using Signal Attenuation

When the **ATT** LED is on, the incoming signal strength is attenuated (reduced) by about 15 dB. This prevents unusually strong signals from over-loading the scanner.

In the Scan Mode, you must individually program each channel you want to use the Signal Attenuation feature. You can use the Signal Attenuation feature in the Manual, Search, or Scan Mode.

Use these keys:

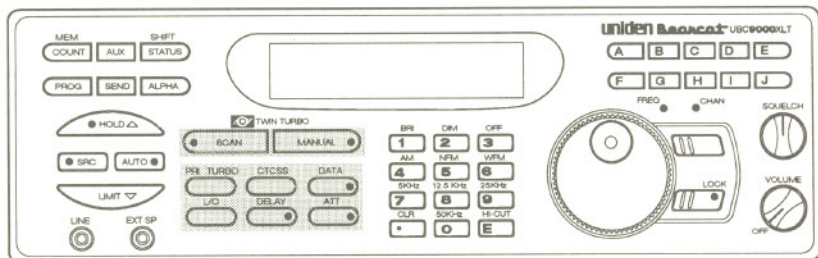

Scan, and Mode Keys

While Scanning:

1. Press **MANUAL**.

Bank D ch 83
855.9125MHz

2. Press **ATT**. The display does not change.

While Searching, press **ATT**.

Preventing Accidental Programming

The UBC9000XLT has a lock feature to prevent accidental programming entries. To disable the **E**, **PROG**, **SEND**, and **AUTO** keys, move the rear panel switch to ON.

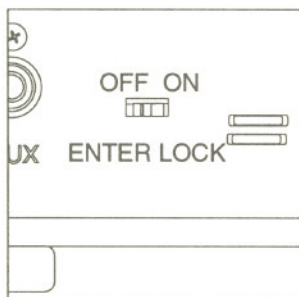

When you press **E**, **PROG**, **SEND**, or **AUTO**, a message appears.

Bank C ch 69
ENTER LOCKED

Using COUNT to Monitor Channel Activity

The Count feature counts the number of times scanning stops on an active channel. Use Count to determine the amount of activity on channels during a scanning session.

Use these keys:

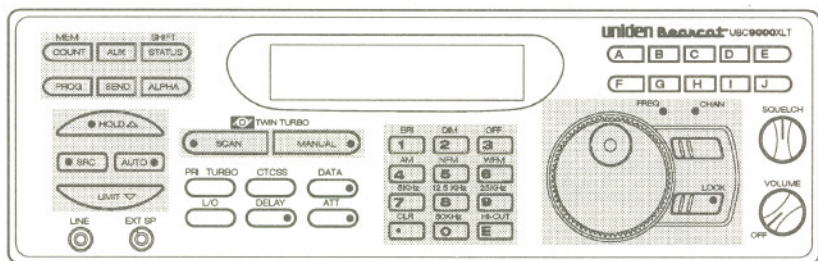

Status, Search, Scan, Numeric Keys, and Rotary Tuning Controls

1. Press **MANUAL**.



Bank A P ch 1
482.7625MHz

2. Press **COUNT**.

Count:01P ch 1
482.7625MHz

3. Press **MANUAL**, , , or use the Rotary Tuner to see the count for each channel.

Counter counts up to 99. To reset the counter for individual channels

1. Press **MANUAL**.
2. Enter the channel number or use , , or the Rotary Tuner to select the channel.

Count:01P ch 1
482.7625MHz

3. Press **CLR** twice.

Count:00P ch 1
482.7625MHz

Note: Turning off power resets the counter for all channels.

To turn COUNT off:

Press **COUNT**.

Bank A P ch 1
482.7625MHz

Displaying Bank Memory Status

This feature shows the programming status of the channels in a bank.

Use these keys:

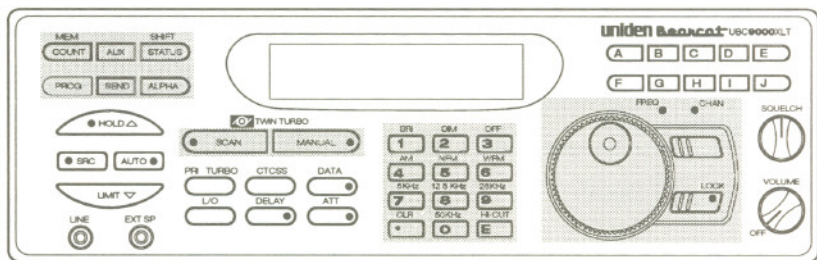

Status, Scan, and Numeric Keys, and Rotary Tuning Controls

1. Press **MANUAL**.
2. Enter the channel number or use the Rotary Tuner to select any channel in the bank.
3. Press and hold **COUNT** for two seconds.

Bank E ch 110
854.9800MHz

Bank E P**_*_*_*L
LL*_____

The display shows:

The bank (**A** through **J** or **0** through **9**)

An asterisk character (*) to represent each programmed channel.

An underscore (_) character for an unprogrammed channel

A "P" to designate a Priority channel

A "L" to show a channel that is locked out.

To check bank memory status in other banks, turn the Rotary Tuner to move from one bank to the next.

To exit from this mode, press **MANUAL** or **SCAN**.

Using Auto Recording

The Auto Recording feature allows you to automatically tape record activity from any channel of your scanner. When scanning stops on the assigned channel, the recorder records the broadcast.

Before using the Auto Tape feature, connect the scanner to a tape recorder. (See page 6.)

Use these keys:

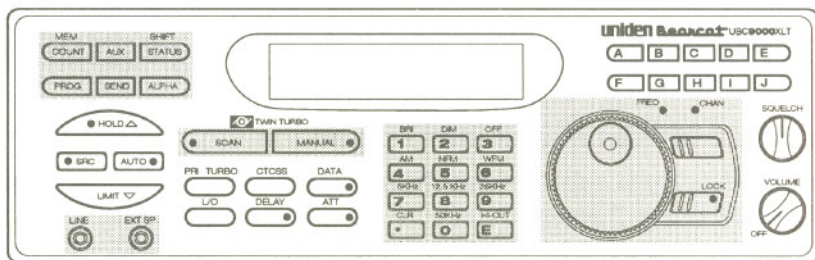

Status, Scan, and Numeric Keys, Rotary Tuning Controls, Line jack

1. Press **SCAN**.

Bank A P ch 1
482.7625MHz

2. When the scanner stops on a channel you want to record, press **MANUAL**, then press **AUX**.

Record ch 1
482.7625MHz

Note: You can also select the channel manually.

To select other channels for recording, repeat steps 1 and 2.

To record transmissions, you need a tape recorder with Remote and Microphone inputs.

1. Connect the REMOTE jack of your tape recorder to the AUX jack on the rear of the UBC9000XLT. This can be used to start and stop your recorder.
2. Put a tape in your recorder, and put it in the Record mode.
3. Press **SCAN**.

When scanning stops on a channel that displays “**Record**”, the channel will automatically be recorded.

To deselect a channel so that it is not recorded:

1. Display the assigned channel on your screen.

Record ch 1
482.7625MHz

2. Press **ALX**.
“**Record**” disappears on the display to indicate that channel will not be recorded.

Bank A P ch 1
482.7625MHz

Viewing Scanner Status Information

This feature lets you quickly review the settings for several features of the UBC9000XLT. Use these key:

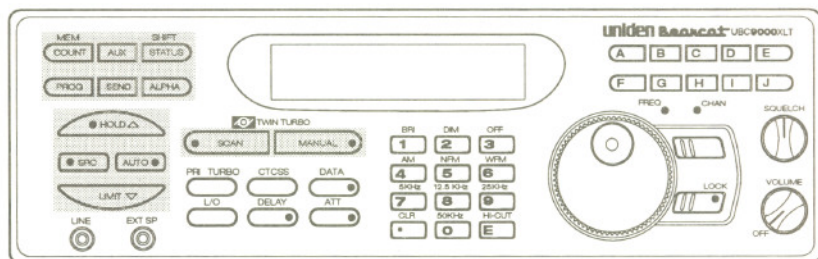

Status, Search, and Scan Keys

In Scan Mode:

1. Press **MANUAL**.

Bank C ch 72
854.2875MHz

2. Press and hold **STATUS** for two seconds. You hear two beeps, then the status information scrolls across the display.

Bank C ch 72
MODE:NFM

Bank C ch 72
STEP:12.5KHz

Bank C ch 72
CTCSS:OFF 000.0

Bank C ch 72
HI-CUT:OFF

Bank C ch 72
RECORD:OFF

Bank C ch 72
DIMMER: BRIGHT

In Search Mode:

1. Press  to stop the search.

5.0KHz ch 230
NFM 46.0550MHz

2. Press and hold  for two seconds.

You hear two beeps, then the status information scrolls across the display.

5.0KHz ch 10
MODE:NFM

5.0KHz ch 10
HI-CUT:OFF

5.0KHz ch 10
DIMMER: BRIGHT

5.0KHz ch 10
TURBO SRCH: ON

Use these keys for **Display Light** and **Hi-Cut**

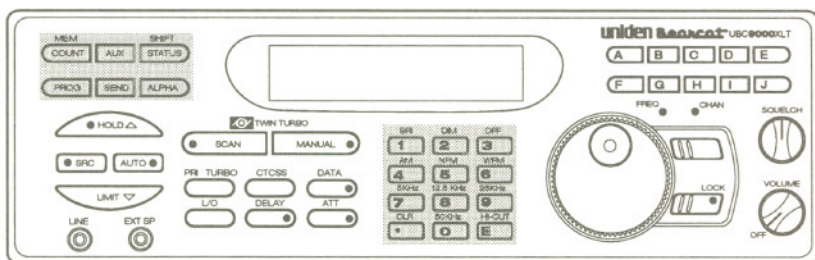

Status and Special Function Keys

Display Light

The Display Light has three settings: BRIGHT, DIM, and OFF.

1. Press **SHIFT**.
2. Press the setting.
Example: Press **OFF**.



Using Hi-Cut

To Turn HI-CUT ON or OFF:

1. Press **SHIFT**.
2. Press **HI-CUT**.



You can turn HI-CUT on or off while searching or scanning.

CTCSS Operation

This section applies only if you are installing and using an optional CTCSS Tone Board with your scanner.

Installing the CTCSS Board

Installing the CTCSS Tone Board is a simple procedure, and requires only a few minutes following the steps below.

CAUTION: *Be sure to turn the scanner off and disconnect the power cord before attempting to open the scanner.*

1. Remove the five screws from the top cover.

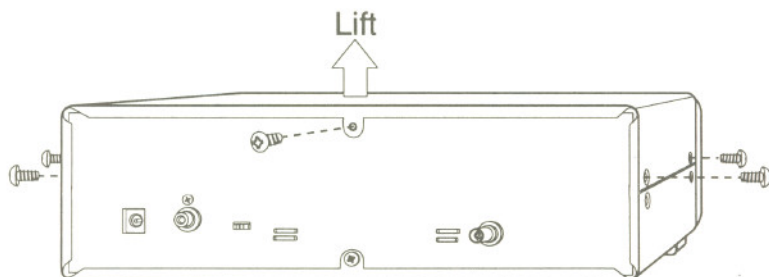

2. Carefully lift the cover up from the back of the unit and turn it to the left – being careful not to break the speaker wire.
3. Stand the cover on its left side panel.

(Continued, next page)

4. Align the pins on the CTCSS Board with the sockets on the mother board. Make sure they go **straight** into the sockets. The 4 pin socket is toward the front of the scanner. The 3 pin socket is toward the back of the scanner.

5. Gently push straight down on the CTCSS Board until the pins are fully seated in the sockets.

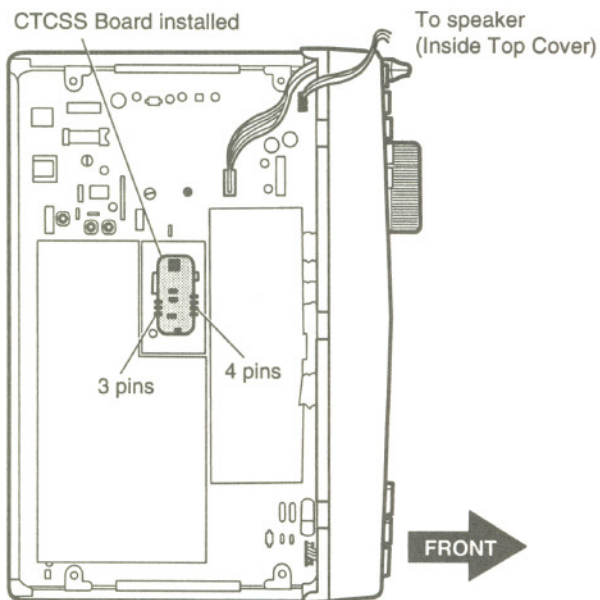

6. Carefully replace the cover and the five screws.

Note: The tabs on the cover hook under the front part of the chassis.

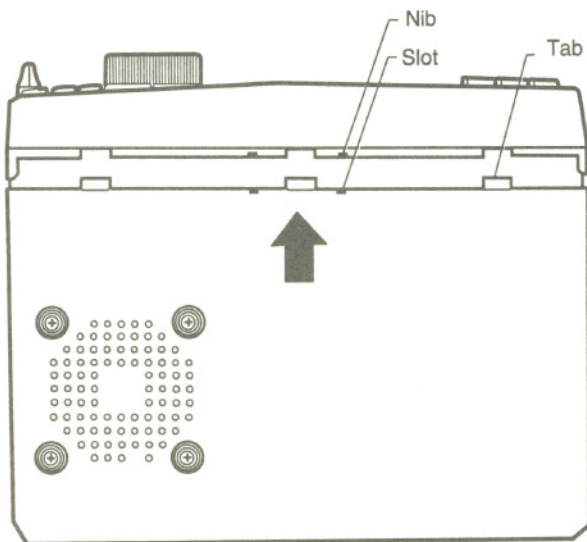

Using CTCSS

The CTCSS (Continuous Tone Control Squelch System) feature allows squelch to be broken during scanning only when a CTCSS Tone is received.

To program a channel for CTCSS, use these keys:

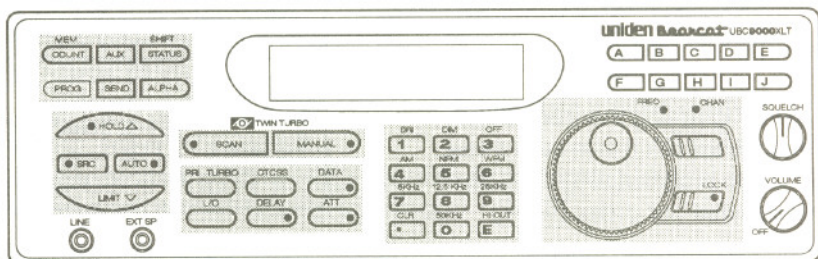

Program, Search, Scan, Mode, and Numeric Keys, and Rotary Tuning Controls

1. Press **MANUAL** .

Bank A ch 8
855.9125MHz

2. Press **PROG** .

Select
ALPHA or CTCSS

3. Press **CTCSS** .

Select chan 8
from 1 to 500

4. Enter the channel number.

72
from 1 to 500

5. Press **HOLD** .

00.0kHz ch 72
854.2875MHz

6. Use the Rotary Tuner to select a tone frequency. (See page 49 for a list of tone frequencies.)



7. Press **E** to program the frequency.

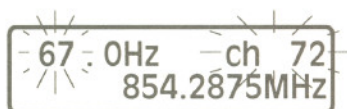

After programing the frequency, the scanner returns to step three. Continue programming CTCSS frequencies , or press **MANUAL** to exit.



To Change the CTCSS Tone Frequency

1. Press **MANUAL** .
2. Find the channel and CTCSS Tone Frequency you want to change.

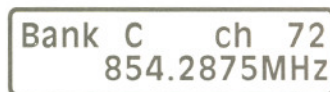

3. Press **PROG** .



4. Press **CTCSS** .



5. Enter the current channel number.



6. Press **HOLD** .



7. Use the Rotary Tuner to select a new frequency. (See below for a list of CTCSS tone frequencies.)

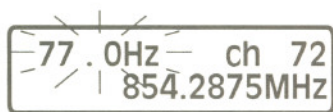

8. Press **E**.

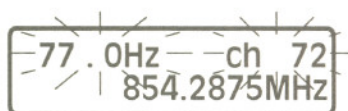

After programming the frequency, the scanner returns to step four. Continue programming CTCSS frequencies, or press **MANUAL** to exit.



Note: To remove a CTCSS Tone Frequency, from a channel, program the frequency as "00.0"

CTCSS Tone Frequencies

000.0	⇒	67.0	71.9	74.4	77.0	79.7	82.5	85.4	88.5	91.5
94.8	97.4	100.0	103.5	107.2	110.9	114.8	118.8	123.0	127.3	131.8
136.5	141.3	146.2	151.4	156.7	162.2	167.9	173.8	179.9	186.2	192.8
203.5	210.7	218.1	225.7	233.6	241.8	250.3	←	000.0		

Care and Maintenance

General Use

Write down the programmed channels/frequencies in case of a memory loss.

Firmly press each scanner key so that you hear the entry tone.

Location

If strong interference or electrical noise is received, move the scanner. Also, a higher antenna location usually results in better reception.

Do not use the scanner in high-moisture environments, such as a kitchen or bathroom.

Avoid placing the scanner in direct sunlight or near heating elements or vents.

Cleaning

Disconnect the AC adaptor while you clean the scanner.

Clean only the outside of the scanner with a mild detergent.

To prevent scratches, do not use abrasive cleaners or solvents to clean the scanner.

Do not rub the display window.

Do not use excessive amounts of water.

Repairs

Do not attempt any repairs. The scanner contains no user-serviceable parts. Contact the Uniden Customer Service Division or take the scanner to a qualified repair technician.

Troubleshooting

If your UBC9000XLT is not performing properly, try the steps listed below.

PROBLEM	SUGGESTION
Scanner won't work.	Check the connections at both ends of the AC Adaptor. Turn on the wall switch of your room. Move the AC Adaptor to another wall outlet. Make sure the power switch is turned on.
Poor reception.	Check the antenna and its connection. You may be in a fringe area. This may require an optional multi-band antenna. Check with your dealer or local electronics store.
Scan won't stop.	Adjust the Squelch Control. Check the antenna connection. It is possible that none of the programmed channels are active at the time. Try the band search.
Scan won't start.	Press the bank key again. Make sure there are some programmed channels. Adjust the Squelch Control.
Search won't start.	Adjust the Squelch Control.
Scanner won't allow any program inputs	Check the Enter Lock feature.
Can't program channel with alpha character	Alpha character programming is available up to 250 channels. Make sure the programmed channel is within that range.

If you still cannot get satisfactory results and want additional information, or to return the unit for service, please call Uniden Customer Service Division. The address and phone number are listed in the Warranty. (at the end of this manual)

Optional Accessories and Replacement Parts

Operating Guide
(OMUBC9000XLT)



Telescoping Antenna
(AT124)



AC Adaptor
(AAD 8500U)

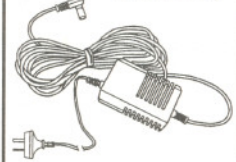

External Speaker
(ESP25, 8Ω)



Mobile Mounting Bracket
Assembly Kit
(MB001)

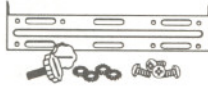

Cigarette Lighter
Power Cord Adaptor
(PS001)

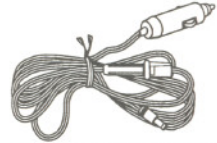

Hard Wire Cord
(PS002)



CTCSS Board
(BC005)



Specifications

Banks: Total 20 banks
Channels: 500 channels
Search Band: Total 16 Search bands(AM, NFM, WFM)
Frequency Range:

	Frequency Coverage (MHz)	Mode	Step in kHz
1	25.0000 – 28.9950	AM	5.0
2	29.0000 – 55.9950	NFM	5.0
3	56.0000 – 69.9500	WFM	50.0
4	70.0000 – 87.9950	NFM	5.0
5	88.0000 – 107.9500	WFM	50.0
6	108.0000 – 136.9875	AM	12.5
7	137.0000 – 173.9950	NFM	5.0
8	174.0000 – 221.9500	WFM	50.0
9	222.0000 – 399.9875	AM	12.5
10	400.0000 – 519.9875	NFM	12.5
11	520.0000 – 549.9500	WFM	50.0
12	760.0000 – 823.9875	NFM	12.5
13	824.0100 – 848.9700	NFM	30.0
14	849.0000 – 868.9875	NFM	12.5
15	869.0100 – 893.9700	NFM	30.0
16	894.0000 – 1300.0000	NFM	12.5

Scan Rate: Up to 100 channels per second

Search Rate: Up to 300 steps per second (Turbo Mode)

Up to 100 steps per second (Normal Mode)

Scan Delay: 2 seconds

Audio Output: Max 3W (8 Ω load)

Antenna: 50 ohms (Impedance)

Operating Temperature: -10°C to + 50°C

Size: 267 (W) \times 189.5 (D) \times 85 (H) mm

Weight: 1820g

Features, specifications, and availability of optional accessories are all subject to change without notice.

Warranty

Uniden UBC9000XLT Auto Scanner Australian 1 Year Warranty

Note: Please keep your sales docket as it provides evidence of warranty.

WARRANTOR: Uniden Australia Pty. Limited ACN 001 865 498

ELEMENTS OF WARRANTY: Uniden warrants to the original retail owner for the duration of this warranty, its UBC9000XLT Auto Scanner (hereinafter referred to as the product), to be free from defects in materials and craftsmanship with only the limitations or exclusions set out below.

WARRANTY DURATION: This warranty to the original retail owner only, shall terminate and be of no further effect ONE (1) Year after the date of original retail sale. This warranty will be deemed invalid if the product is; (A) Damaged or not maintained as reasonable and necessary, (B) Modified, altered or used as part of any conversion kits, subassemblies, or any configurations not sold by Uniden, (C) Improperly installed, (D) Repaired by someone other than an authorized Uniden Repair Agent for a defect or malfunction covered by this warranty, (E) Used in conjunction with any equipment or parts or as part of a system not manufactured by Uniden, (F) Installed, programmed or serviced by anyone other than an authorized Uniden Repair Agent, (G) Where the Serial Number label of the product has been removed or damaged beyond recognition.

PARTS COVERED: This warranty covers for 1 year, the UBC9000XLT Auto Scanner Unit Only. Telescopic Antenna, AC Adaptor and other accessories are covered for 90 days.

STATEMENT OF REMEDY: In the event that the product does not conform to this warranty at any time while this warranty is in effect, the warrantor at its discretion, will repair the defect or replace the product and return it to you without charge for parts and service.

THIS WARRANTY DOES NOT COVER OR PROVIDE FOR THE REIMBURSEMENT OR PAYMENT OF INCIDENTAL OR CONSEQUENTIAL DAMAGES.

WARRANTY CARD: If a warranty card has been included with this product then please fill it in and return it to us within 14 days of purchase. Your name and serial number of the product will then be registered in our database and this will help up process your claim with greater speed and efficiency should you require warranty service.

PROCEDURE FOR OBTAINING PERFORMANCE OF WARRANTY: In the event that Product does not conform to this warranty, the Product should be shipped or delivered, freight pre-paid, with evidence of original purchase, (eg/a copy of the sales docket), to the warrantor at:

**UNIDEN AUSTRALIA PTY. LIMITED
SERVICE DIVISION**

**345 Princes Highway, Rockdale, NSW 2216
Ph (02) 599 3100 FAX (02) 599 3278**

**Customers in other States should ship or deliver the Product
freight pre-paid to their nearest Uniden Authorized Repair Centre.
(Contact Uniden for the nearest Warranty Agent to you)**

uniden®

Bearcat®

©1995 Uniden Australia Pty. Limited. All rights reserved.

UBZZ01248AZ

Printed in the Philippines